

AT 20-3

**Features: AT 20-3**

- ▶ 20 tonne at 1.4 m radius
- ▶ 1.60 tonne at 15.8 m radius
- ▶ 17 m maximum hook height
- ▶ Hook block (4 parts) capacity 16.8 tonne
- ▶ Single line 4.2 tonne

Key

.....	3
-------	---

Dimensions

Crane dimensions	4, 5
Range diagram	6
Area of operation	7

Load charts

Fallblock	8
Fallblock, manual	9

Technical description

Boom and Jib	10
Winch	10
Engine and transmission	10
Hydraulic system	11
Chassis	11
Tyres	11
Vehicle performance	12
Cab, controls, and operator aids	12

	Boom length		Speed
	Hook height		Slewing / Allowable slewing range
	Boom with jib		Crane / Crane in standard configuration
	Telescoping mode		Gradeability
	Boom elevation angle		Gross vehicle weight
	Working radius		Weight on front axle
	Hook and block		Weight on rear axle
	On rubber		Controls
	Main winch		Cab
	Winch speed		Air conditioning / Cab heating
	Engine		Operator aids / Load limiter / Load indicator
	Transmission		Rope – Standard / Optional
	Hydraulics		Rope diameter
	Steering		Rope length
	Tyres		Maximum line pull

DIMENSIONS

AT 20-3

Crane Dimensions

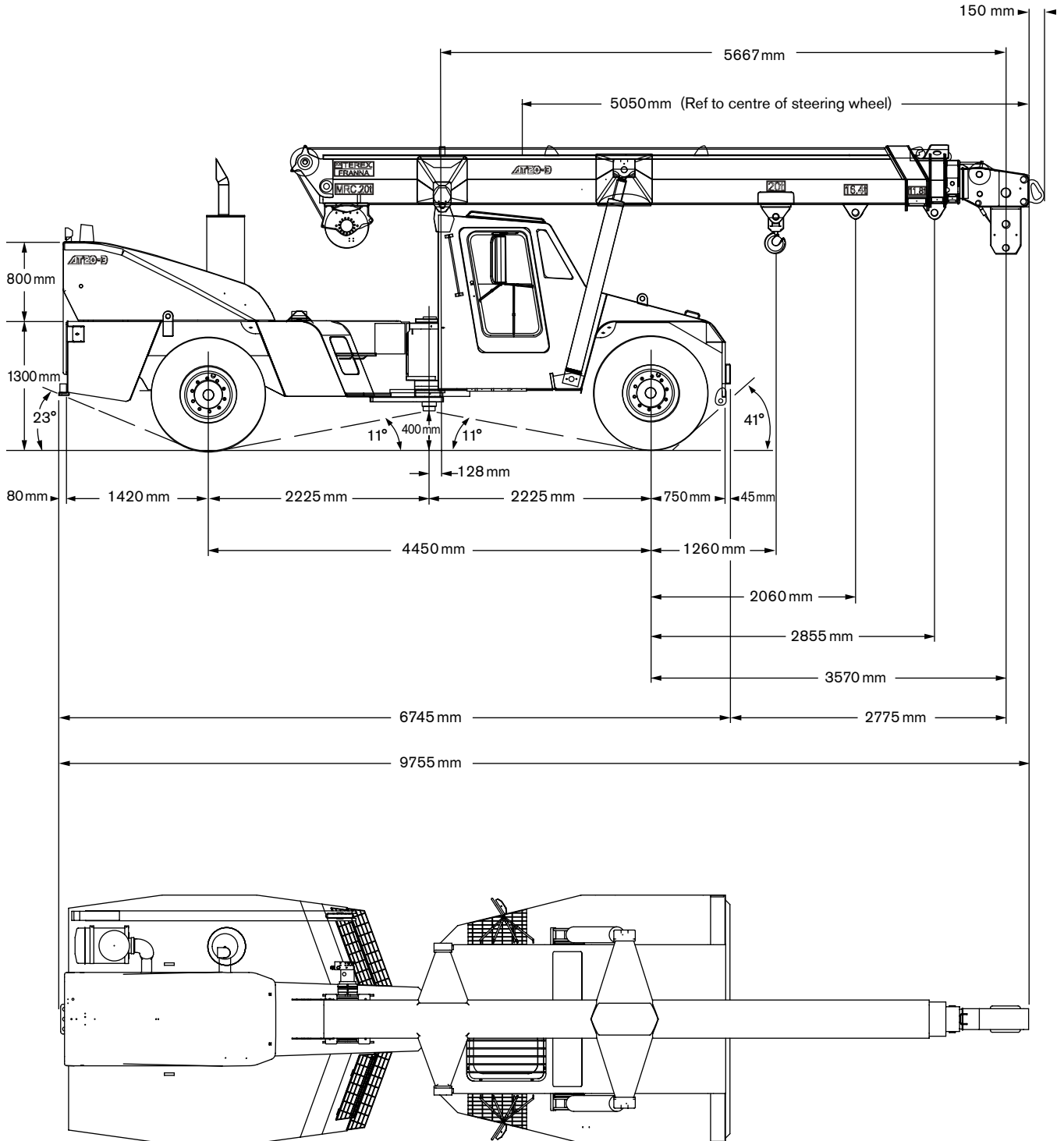

DIMENSIONS

Crane Dimensions

AT 20-3

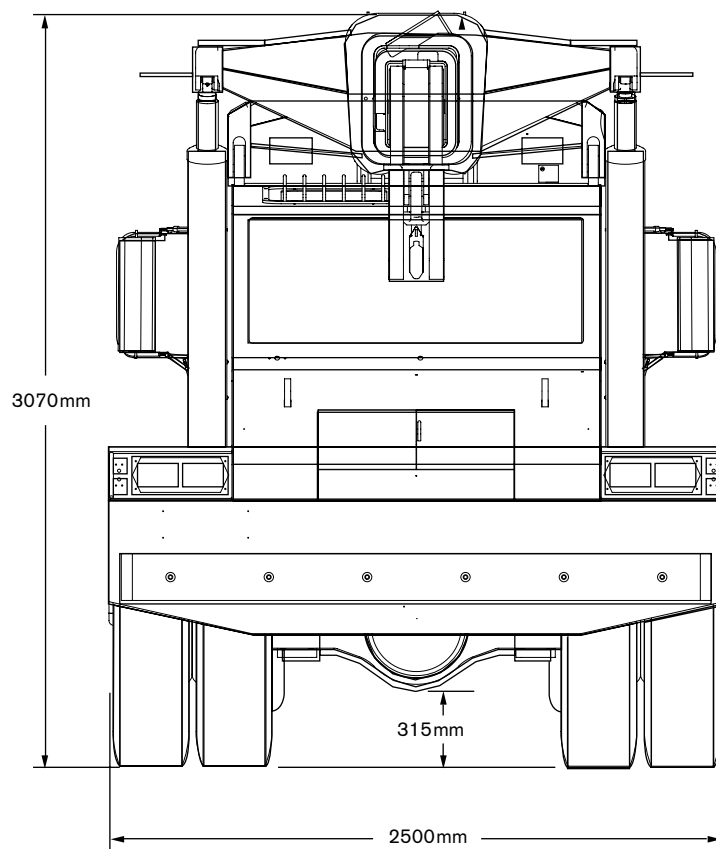

RADIUS LOAD CHART

AT 20-3

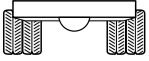

Pick & Carry 0.4m/s (1.44 km/h); On rubber 66.6%

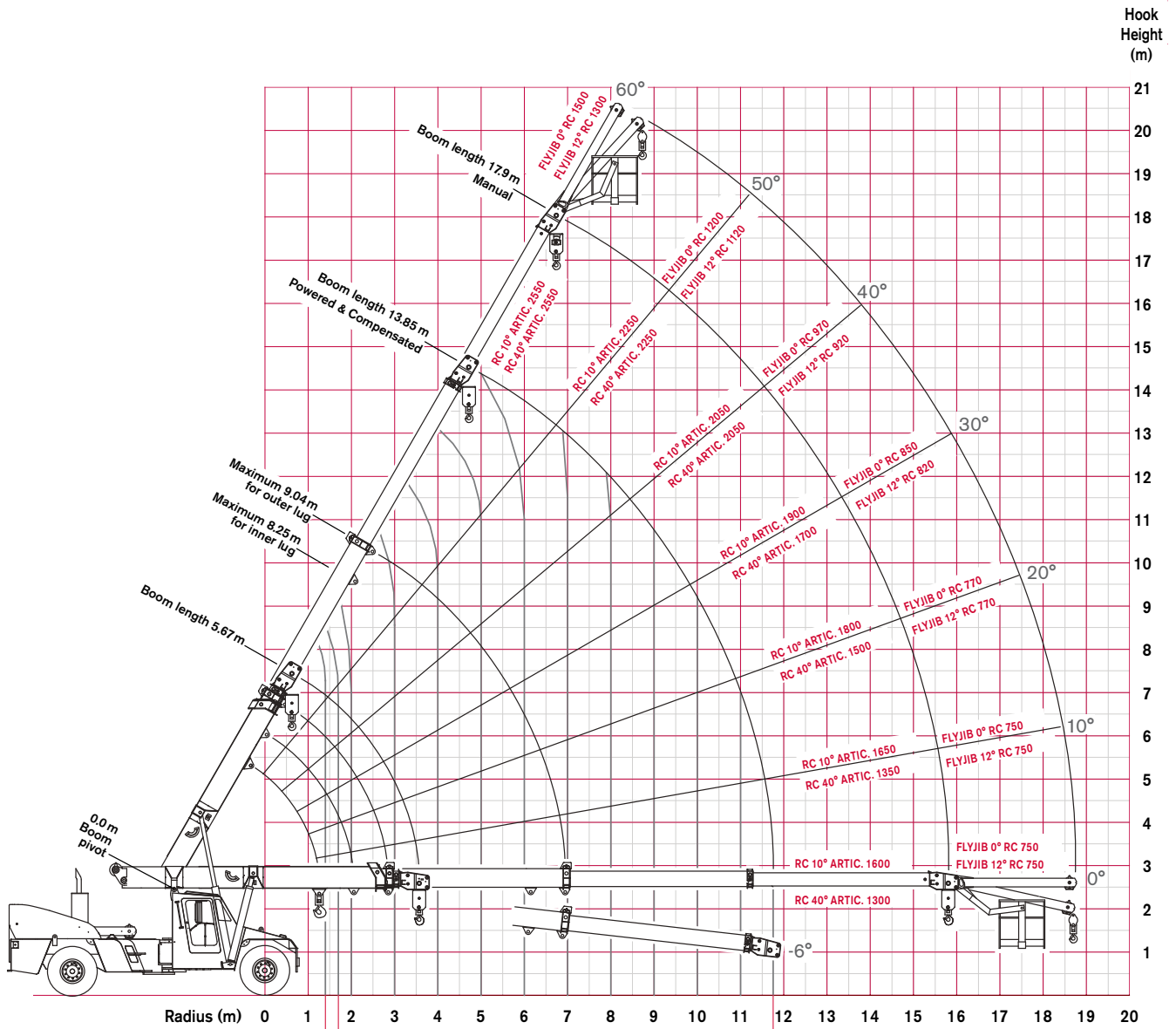

RC AT 1.4M 20000 KG												
RC AT 1.7M 19000 KG												
RC (KG) 10° ARTIC.	16800	11400	8300	6500	5250	4350	3700	3200	2800	2450	2250	WINCH RC (KG) 10° ARTIC.
RC (KG) 40° ARTIC.	12600	9950	7200	5600	4500	3750	3150	2700	2350	2050	1850	WINCH RC (KG) 40° ARTIC.

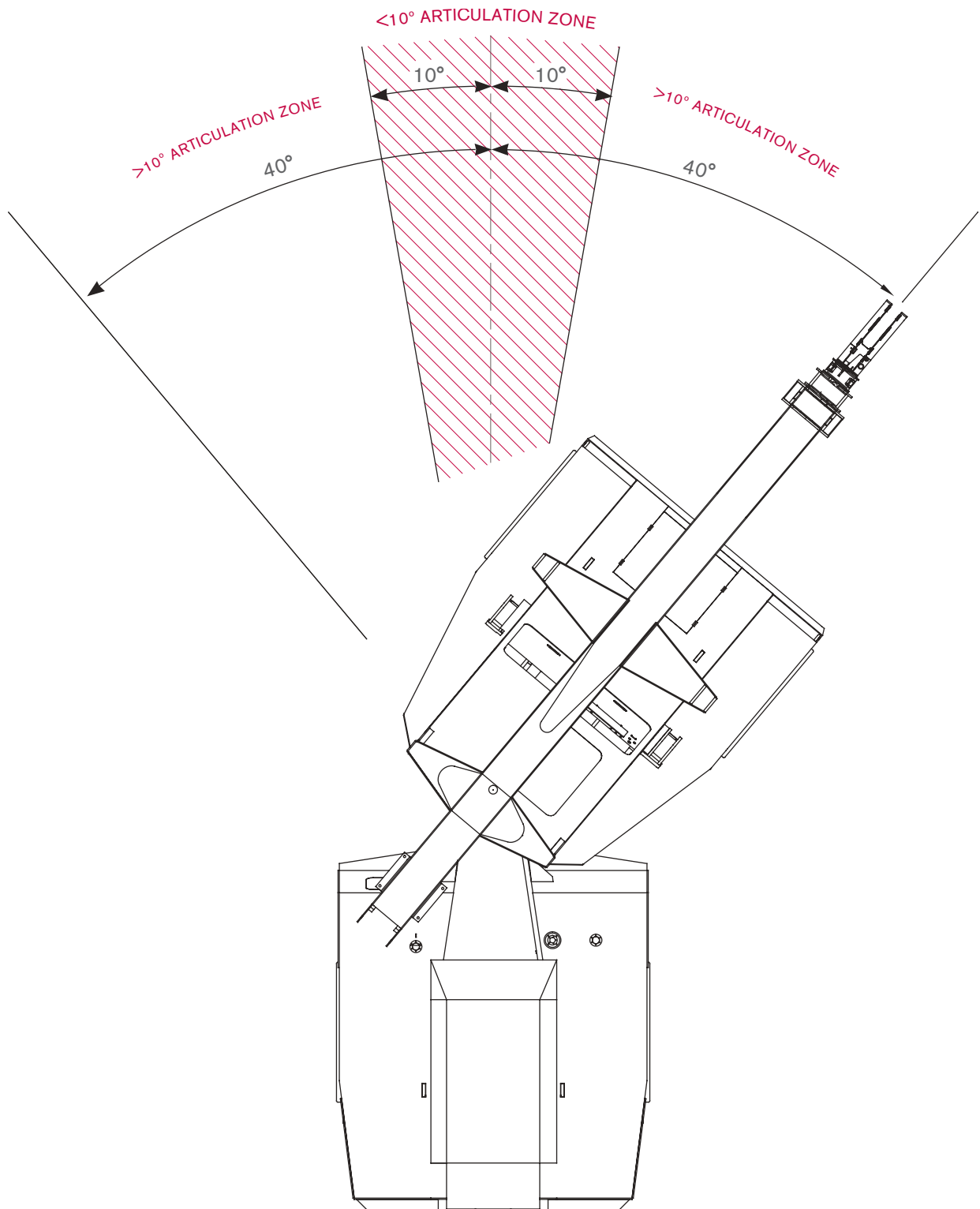

LOAD CHART

AT 20-3

Fallblock

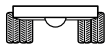

Pick & Carry 0.4m/s (1.44 km/h); On rubber 66.6%



5.67-13.85 m

AS 1418.5

m	Boom Length (m)																		m		
	5.67	6.00	6.50	7.00	7.50	8.00	8.50	9.00	9.50	10.00	10.50	11.00	11.50	12.00	12.50	13.00	13.50	13.85			
kg	kg	kg	kg	kg	kg	kg	kg	kg	kg	kg	kg	kg	kg	kg	kg	kg	kg	kg	kg	m	
1.6	16800	16250	15450	14900																1.6	
	12600	12600	12600	12600																	
	48°	51°	54°	57°																	
2.0	16800	16800	16500	15700	15100	14700	14350													2.0	
	12600	12600	12600	12600	12600	12600	12600														
	42°	46°	50°	53°	56°	58°	60°														
2.5	13900	13900	13900	13850	13850	13850	13850	13200	13000											2.5	
	12150	12150	12100	12100	12100	12100	12100	12050	12050												
	34°	39°	44°	48°	51°	54°	56°	58°	60°												
3.0	11450	11450	11450	11400	11400	11400	11400	11400	11400	11150	10250									3.0	
	9950	9950	9950	9950	9950	9950	9900	9900	9900	9900	9900										
	25°	31°	37°	42°	46°	49°	52°	55°	57°	59°	60°										
3.5	9650	9650	9650	9650	9650	9650	9650	9650	9650	9650	9500	8150	7500							3.5	
	8400	8400	8400	8400	8400	8400	8400	8400	8400	8350	8350	8150	7500								
	8°	20°	29°	36°	41°	45°	48°	51°	53°	55°	57°	59°	60°								
4.0	9450	8550	8350	8350	8350	8350	8350	8350	8300	8300	8300	7600	7000	6700	6450					4.0	
	8200	7450	7250	7250	7250	7250	7250	7250	7200	7200	7200	7200	7000	6700	6450						
	(3.57)	(3.90)	19°	28°	35°	39°	43°	47°	49°	52°	54°	56°	57°	59°	60°						
4.5			7500	7300	7300	7300	7300	7300	7300	7300	7300	7150	6550	6250	6050	5800	5650			4.5	
			6500	6350	6350	6350	6350	6350	6300	6300	6300	6300	6300	6250	6050	5800	5650				
			(4.40)	19°	27°	34°	38°	42°	45°	48°	50°	52°	54°	56°	58°	59°	60°				
5.0				6650	6500	6500	6500	6500	6500	6500	6500	6500	6150	5900	5650	5450	5300	5150		5.0	
				5750	5600	5600	5600	5600	5600	5600	5600	5600	5600	5600	5600	5450	5300	5150			
				(4.90)	18°	27°	33°	37°	41°	44°	47°	49°	51°	53°	55°	56°	58°	59°			
6.0					5950	5350	5250	5250	5250	5250	5250	5250	5250	5250	5050	4850	4700	4600		6.0	
					5100	4600	4550	4550	4550	4500	4500	4500	4500	4500	4500	4500	4500	4500			
					(5.40)	(5.90)	17°	25°	31°	35°	39°	42°	45°	47°	49°	51°	53°	54°			
7.0						4850	4450	4400	4400	4400	4400	4400	4400	4350	4350	4350	4200	3950		7.0	
						4200	3800	3750	3750	3750	3750	3750	3750	3750	3750	3750	3750	3750			
						(6.40)	(6.90)	16°	24°	29°	34°	37°	40°	43°	45°	47°	48°				
8.0									4100	3750	3700	3700	3700	3700	3700	3700	3600		8.0		
									3500	3200	3150	3150	3150	3150	3150	3150	3150				
									(7.40)	(7.90)	15°	23°	28°	32°	36°	38°	41°	43°			
9.0											3500	3250	3200	3200	3200	3200	3200		9.0		
											2950	2750	2700	2700	2700	2700	2700				
											(8.40)	(8.90)	15°	22°	27°	31°	34°	36°			
10.0													3000	2800	2800	2800	2800		10.0		
													2550	2400	2350	2350	2350				
													(9.40)	(9.90)	14°	21°	26°	29°			
11.0															2650	2500	2450	2450	11.0		
															2200	2100	2050	2050			
															(10.40)	(10.90)	13°	18°			
11.75																2350	2250		11.75		
																1950	1850				
																(11.40)	(11.75)				

- RC (kg) < than 10° articulation
- RC (kg) > than 10° articulation
- Boom angle
- Radius at 0° boom angle
- Loads above red line are structural

Notes to lifting capacity

Lifting capacities do not exceed 66.6% of tipping load. Weight of hook blocks and slings is part of the load, and is to be deducted from the capacity ratings. Consult Rated Capacity Manual for further details.

Note: Data published herein is intended as a guide only and shall not be construed to warrant applicability for lifting purposes. Crane operation is subject to the computer charts and Rated Capacity Manual both supplied with the crane.

LOAD CHART

AT 20-3

Fallblock, Manual

 Pick & Carry 0.4 m/s (1.44 km/h); On rubber 66.6%

 9.72–17.90 m

AS 1418.5

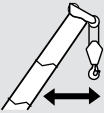
Maximum Radius 	Rated Capacity Maximum Extension Maximum Length 17.90 m
	m / kg
6.74	2550
	2550
	60°
9.31	2250
	2250
	50°
11.53	2050
	2050
	40°
13.34	1900
	1700
	30°
14.67	1800
	1500
	20°
15.51	1650
	1350
	10°
15.80	1600
	1300
	0°

Notes to lifting capacity

Read and understand warning notes before operating crane.

Weight of slings & hook block to be added to load.

Maximum extension length is 17.90 m.

17.9 m boom length includes manual 3rd extension.

Ratings for manual extension are structural and based on boom angle, not radius.





The ratings do not change if the power sections are retracted with the manual section extended.

Lifting capacities do not exceed 66.6% of tipping load.





Weight of hook blocks and slings is part of the load, and is to be deducted from the capacity ratings.

Consult Rated Capacity Manual for further details.



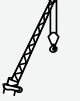

Data published herein is intended as a guide only and shall not be construed to warrant applicability for lifting purposes. Crane operation is subject to the computer charts and Rated Capacity Manual both supplied with the crane.

-  RC (kg) < than 10° articulation
-  RC (kg) > than 10° articulation
-  Boom angle
-  Loads above red line are structural



Boom and Jib

	Four section boom: Main boom, two powered sections, and one manual section (3rd section)	
	Maximum hook height	17 m
	Boom elevation angle range (min. / max.)	-6° / 60°
	Maximum hook height with jib	20 m
	40° articulation each side of centre providing a total 80° slewing arc	80°
	Machinery hook	10 tonne

Winch

	Winch: Fully compensated hook height when telescoping boom 1 and 2	
	Maximum line pull	4.2 tonne
	Two speed winch	41 m/min / 82 m/min
	Hook block, four part, maximum rated capacity	16.8 tonne



Engine and Transmission

	Mercedes OM 906 EUROMOT 3a turbo charged and intercooled diesel engine with hinged engine cover and mid cover for easy serviceability	205 kW
	Engine torque	1110 Nm
	Fuel capacity	440 l
	Fuel type	diesel
	Allison 3000	6-speed automatic
	Transfer Case: Styer VG 750 2:1 ratio High/low range via airshirt 2WD/4WD via airshift, disconnect to rear axle	

Hydraulic System

	Hydraulic Pump:	
	Load sensing axial piston	
	Maximum pump flow rate	130 litre/min
	Maximum working pressure	250 bar
Hydraulic tank with top mounted return and in tank suction filters		200 l

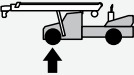
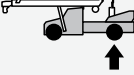
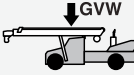
Chassis

	Front Axle: Kessler D71 PL478 heavy duty high speed planetary axle with driver selectable diff lock	8,000 kg
	Rear Axle: Kessler D71 PL478 heavy duty high speed planetary axle	11,500 kg
	Total:	19,500 kg
	Full power Orbitrol with twin hydraulic double acting rams with end stop cushioning Priority flow from main pump supply plus electro hydraulic emergency supply Turning Circle: Outside wheels radius	7.4 m
	Brakes: Air operated high capacity Large wedge style twin circuit service and spring applied park brakes on both front and rear axles Crane operation hold brake on right side front wheel Driver selectable engine exhaust brake is available in all gears - automatically selects converter lockup	
	Suspension: Two semi elliptic springs on front and rear axle plus torsion bar on front axle for stability	



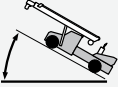

Tyres

	12.00 x 20 bias ply duals 20 in x 8.5 in heavy duty ISO 10 stud 335 PCD spigot mount rims
---	--

Vehicle performance

	Maximum rated travel speed	85 kph
	Gradeability	50%

Cab, Controls, and Operator aids

	Two person, insulated lock up cabin: KAB suspension driver's and passenger seats, including retracting seat belts Colour LCD display Radio/CD player with Bluetooth handsfree Reversing camera Centralised greasing Cruise control Engine monitoring Service diagnostics
	3B6 rated capacity indicator with audio/visual overload pre-warning and motion cut-outs
	3 axis joystick control for crane functions
	Air conditioned and heated

A large rectangular area with a light gray background and horizontal gray lines, intended for writing notes. The lines are evenly spaced and run across the width of the page.

BRISBANE

585 Curtin Avenue East
Eagle Farm QLD 4009
AUSTRALIA

Ph: +61 7 3868 9600
Fax: +61 7 3268 2489

MELBOURNE

187 Osborne Avenue
Clayton South VIC 3169
AUSTRALIA

Ph: +61 3 9551 8644
Fax: +61 3 9551 8143

SYDNEY

114 Hassall Street
Wetherill Park NSW 2164
AUSTRALIA

Ph: +61 2 8786 4444
Fax: +61 2 8786 4455

PERTH

39 Catalano Road
Canning Vale WA 6155
AUSTRALIA

Ph: +61 8 9232 0000
Fax: +61 8 9232 0051

www.terexcranes.com

Effective Date: September 2011. Product specifications and prices are subject to change without notice or obligation. The photographs and/or drawings in this document are for illustrative purposes only. Refer to the appropriate Operator's Manual for instructions on the proper use of this equipment. Failure to follow the appropriate Operator's Manual when using our equipment or to otherwise act irresponsibly may result in serious injury or death. The only warranty applicable to our equipment is the standard written warranty applicable to the particular product and sale and Terex makes no other warranty, express or implied. Products and services listed may be trademarks, service marks or trade-names of Terex Corporation and/or its subsidiaries in the USA and other countries. All rights are reserved. Terex® is a registered trademark of Terex Corporation in the USA and many other countries. Copyright 2011 Terex Corporation..

Terex Cranes, Global Marketing, Dinglerstraße 24, 66482 Zweibrücken, Germany
Tel. +49 (0) 6332 830, Email: info.cranes@terex.com, www.terexcranes.com

Brochure Reference: TC-DS-M-E-AT20-3-09/11



WORKS FOR YOU.™